



# In-home energy flexibility protocols







Opgericht in 2009 door de  
Nederlandse netbeheerders

Bijdrage aan:

- Excellent netbeheer
- Faciliteren energietransitie





# Waar rijden én laden EV's in de toekomst?

De ontwikkeling van elektrische voertuigen en laadpunten in Nederland t/m 2035

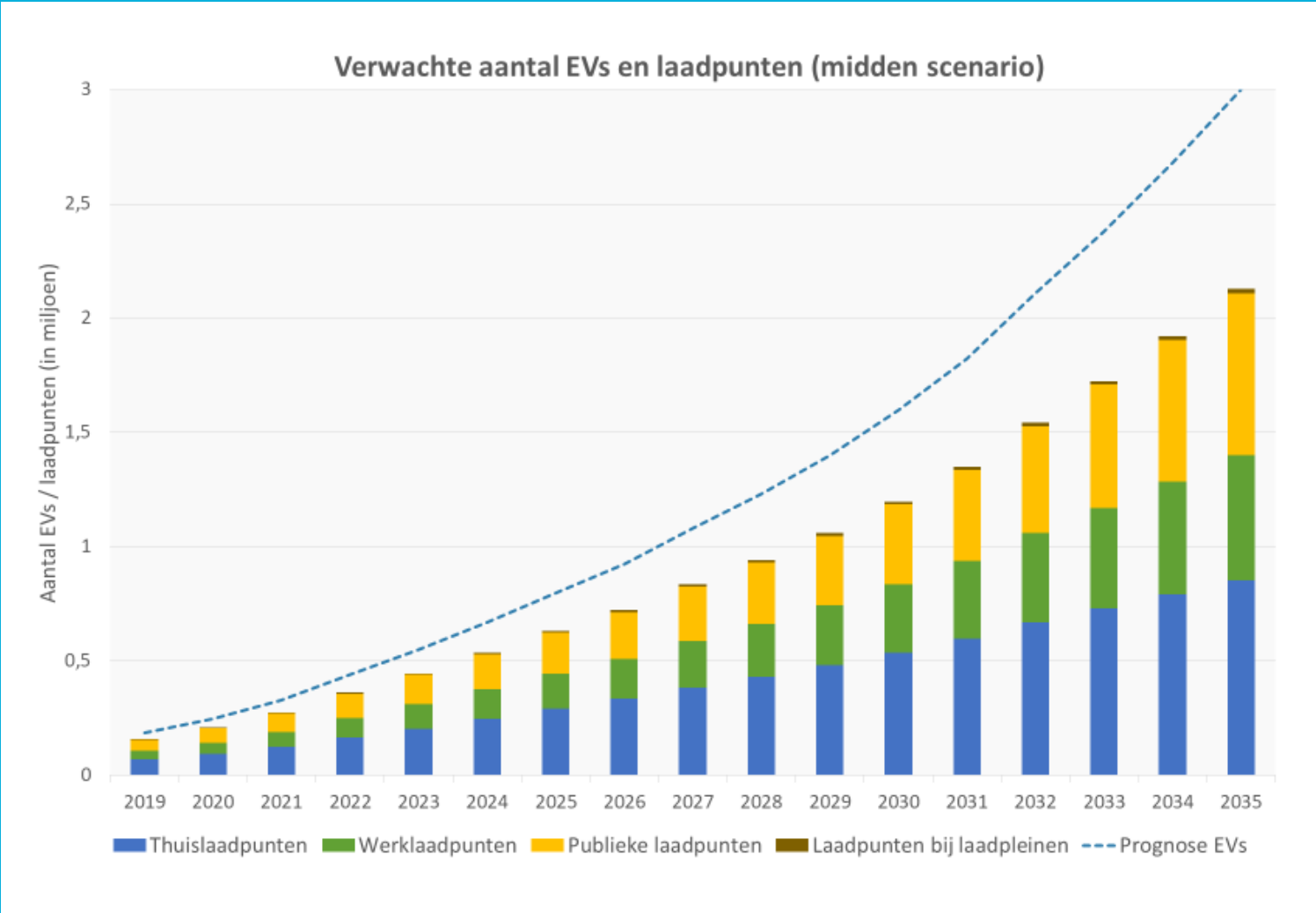



# In-home energy flexibility protocols



## Outside

How does the outside communicate with the inside

Energy Actors



focus of this study

## In home

How do different devices within the home communicate with each other

Device

EMS

CP

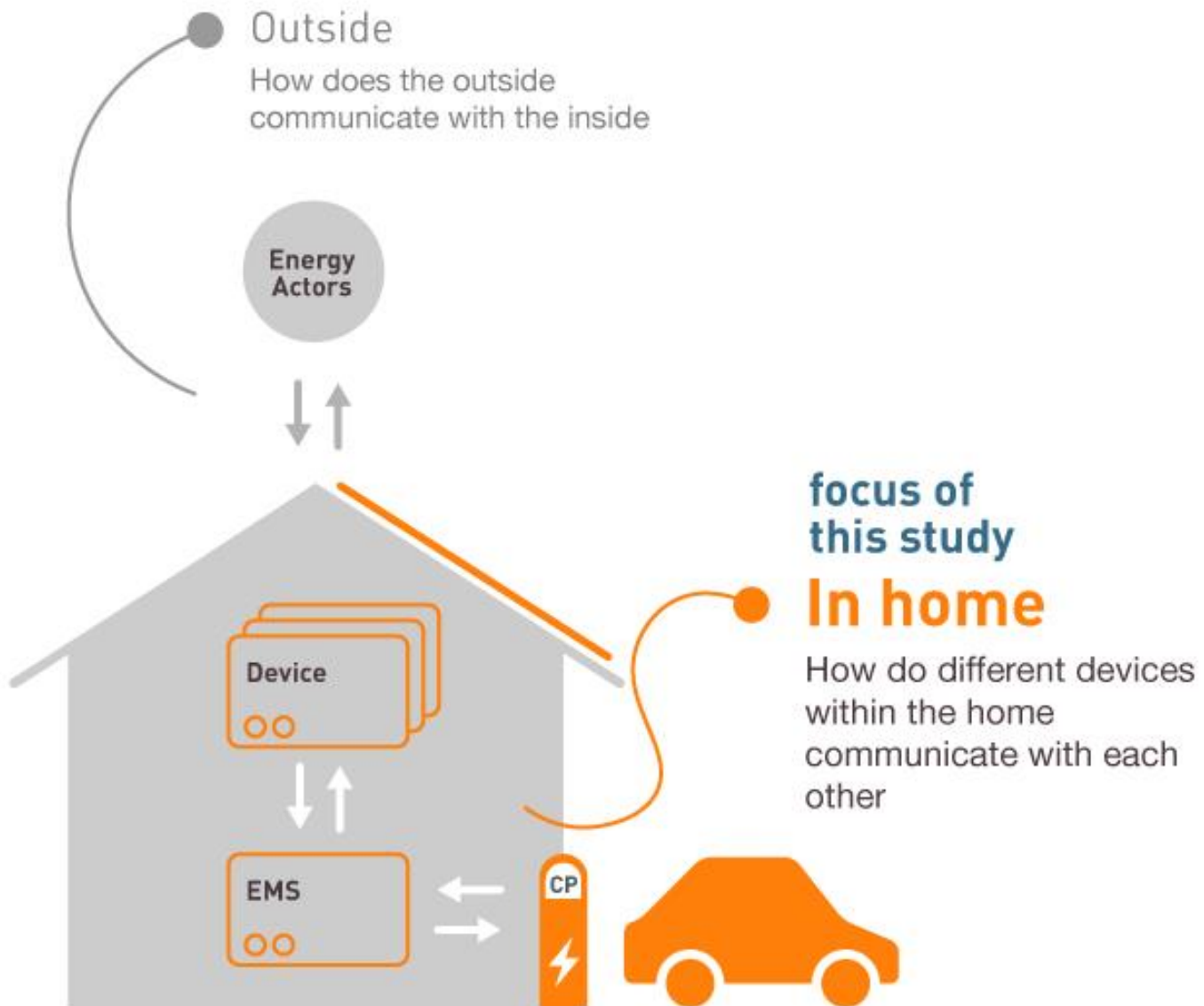

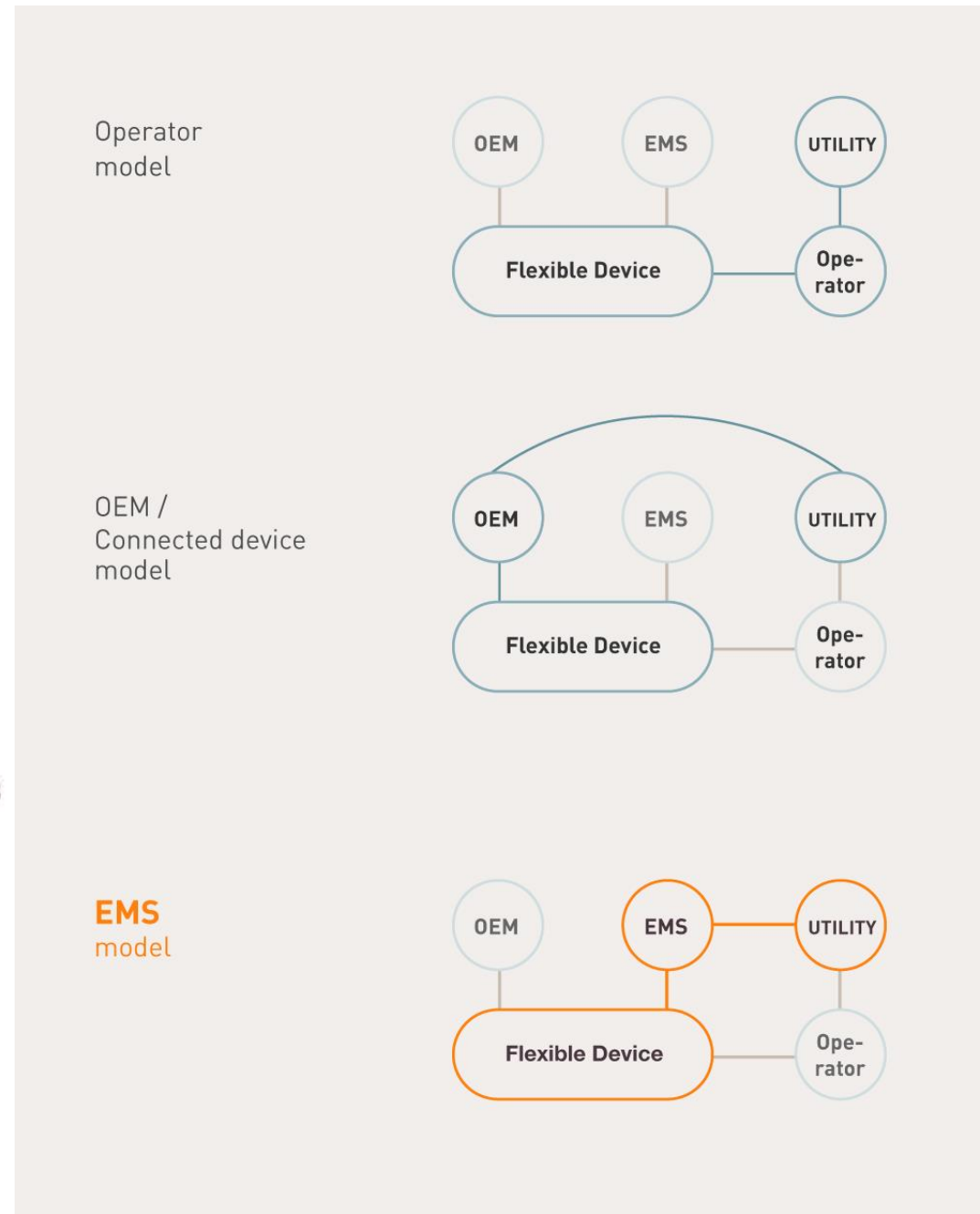
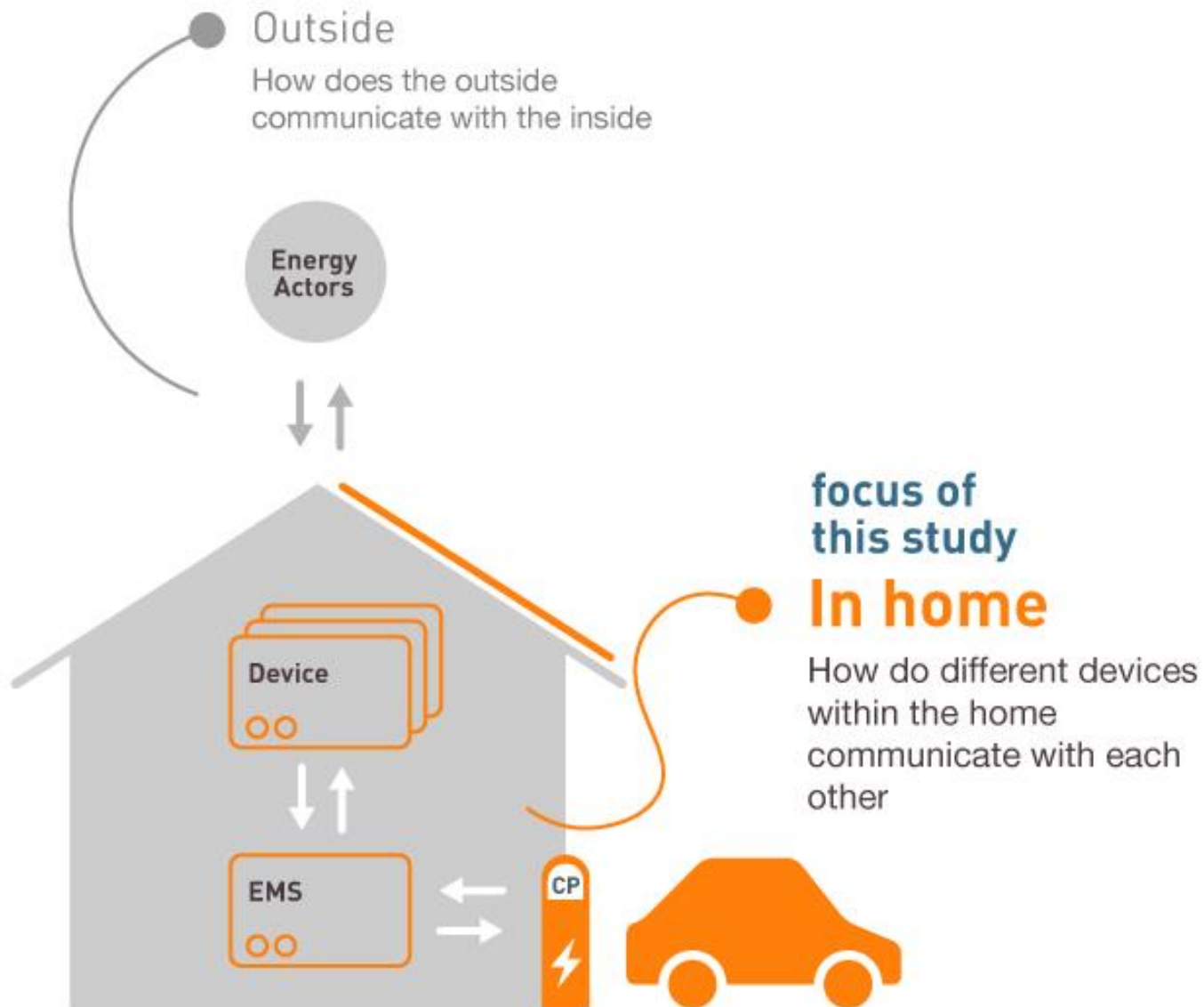



# SMART ENERGY COMMUNITY VOOR WONINGEN EN BEDRIJFSGEBOUWEN

## Poll 1

Wat is het model van uw voorkeur?

1. Operator model
2. OEM model
3. EMS model



# Concept of energy flexibility

"I have bought a new heat-pump.

I can fully control it and I can connect it to my other systems.

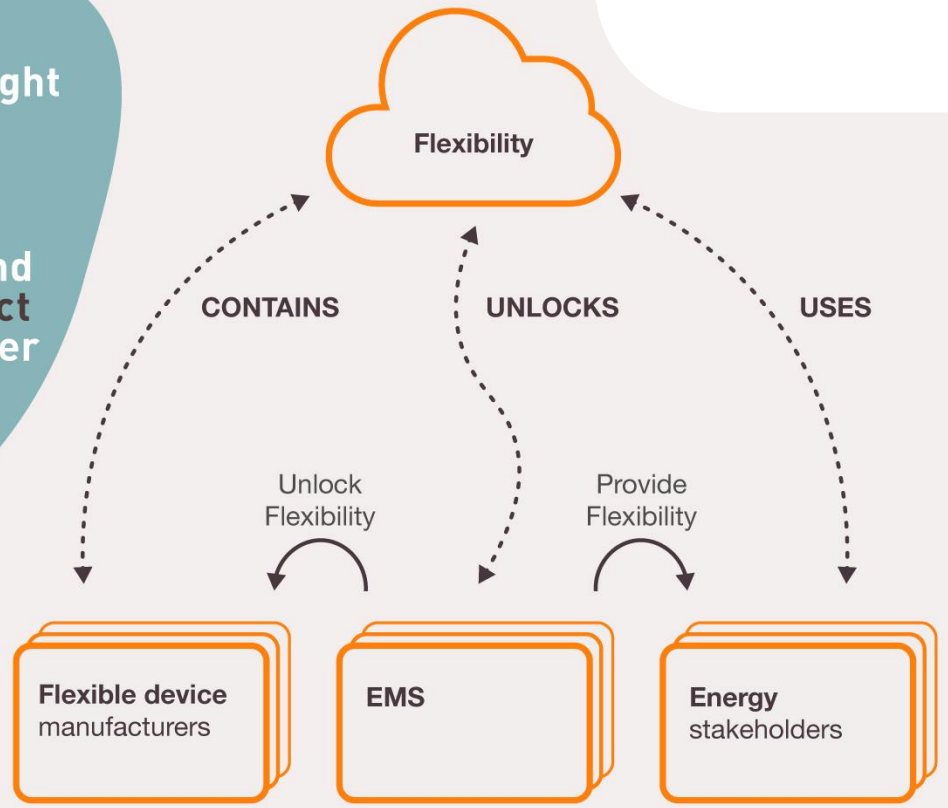
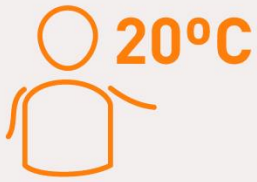

## Challenges →

Unlocking flexibility while preserving user comfort

Unlocking & providing flexibility

Flexibility access



# Concept of energy flexibility

"I have bought a new heat-pump. I can fully control it and I can connect it to my other systems."

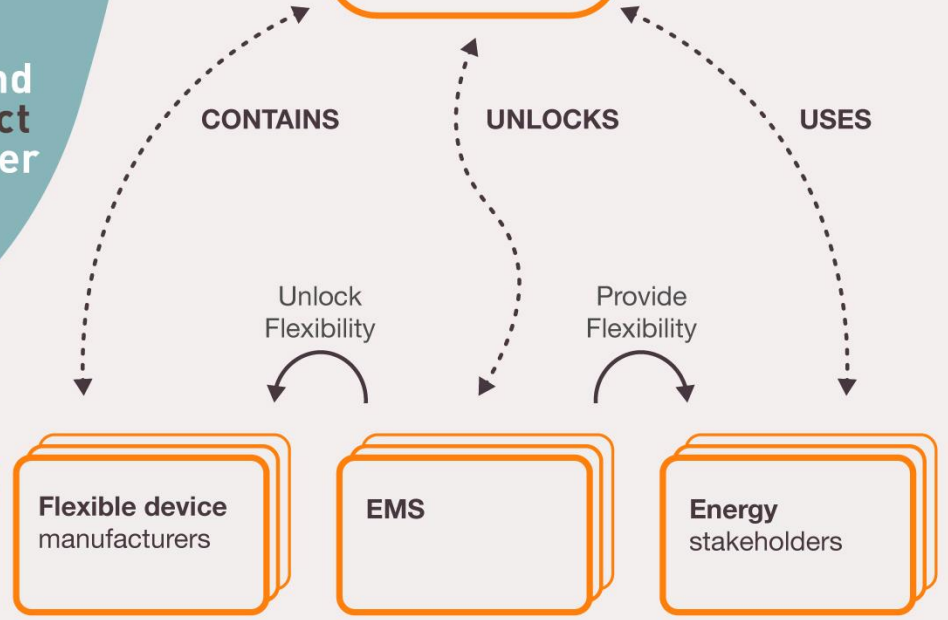

Challenges →	Unlocking flexibility while preserving user comfort	Unlocking & providing flexibility	Flexibility access

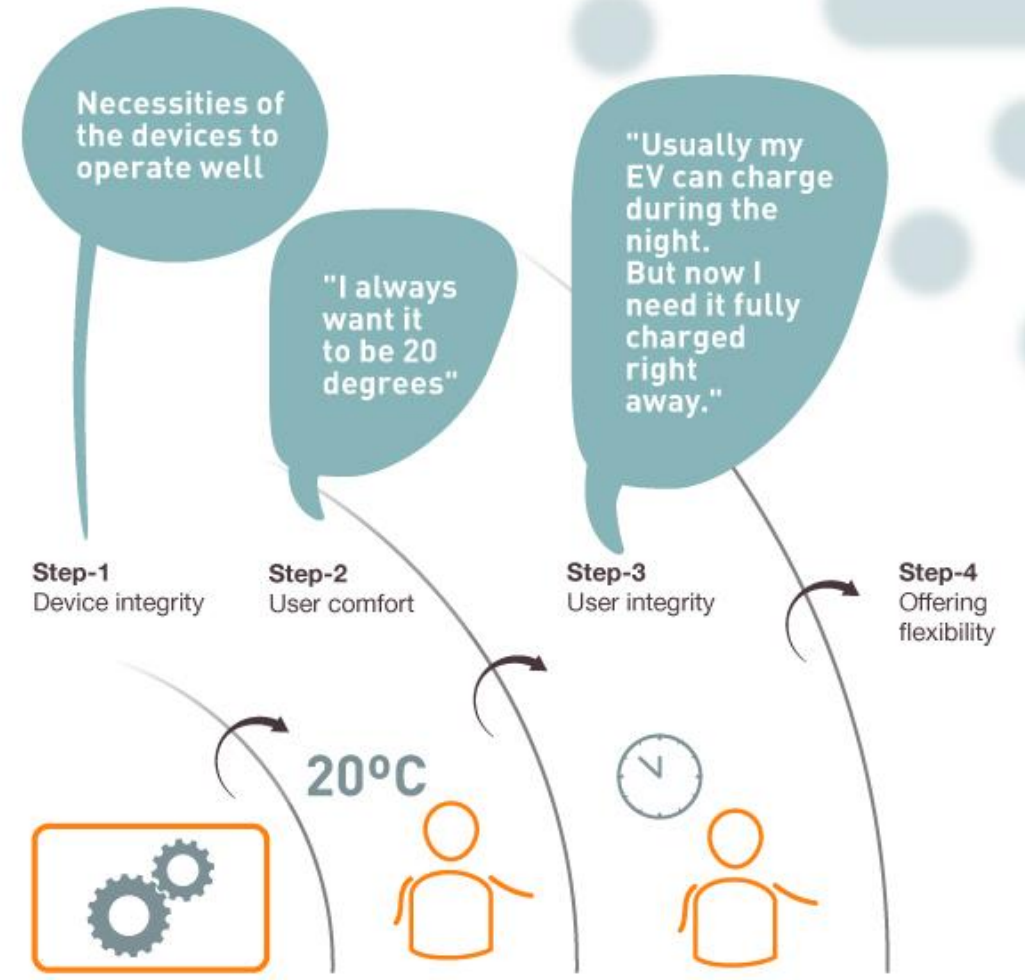

# Functions for flexibility

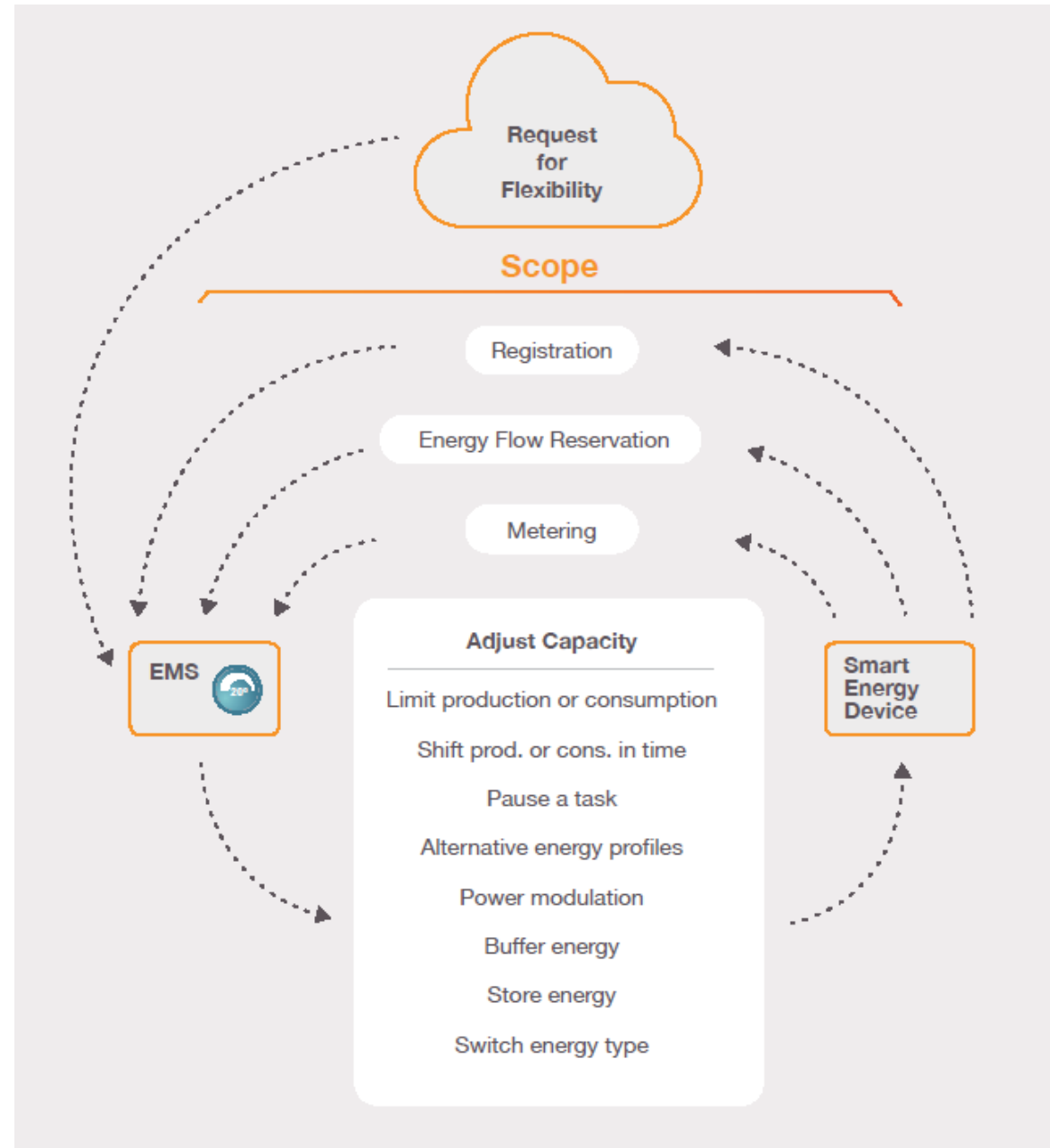

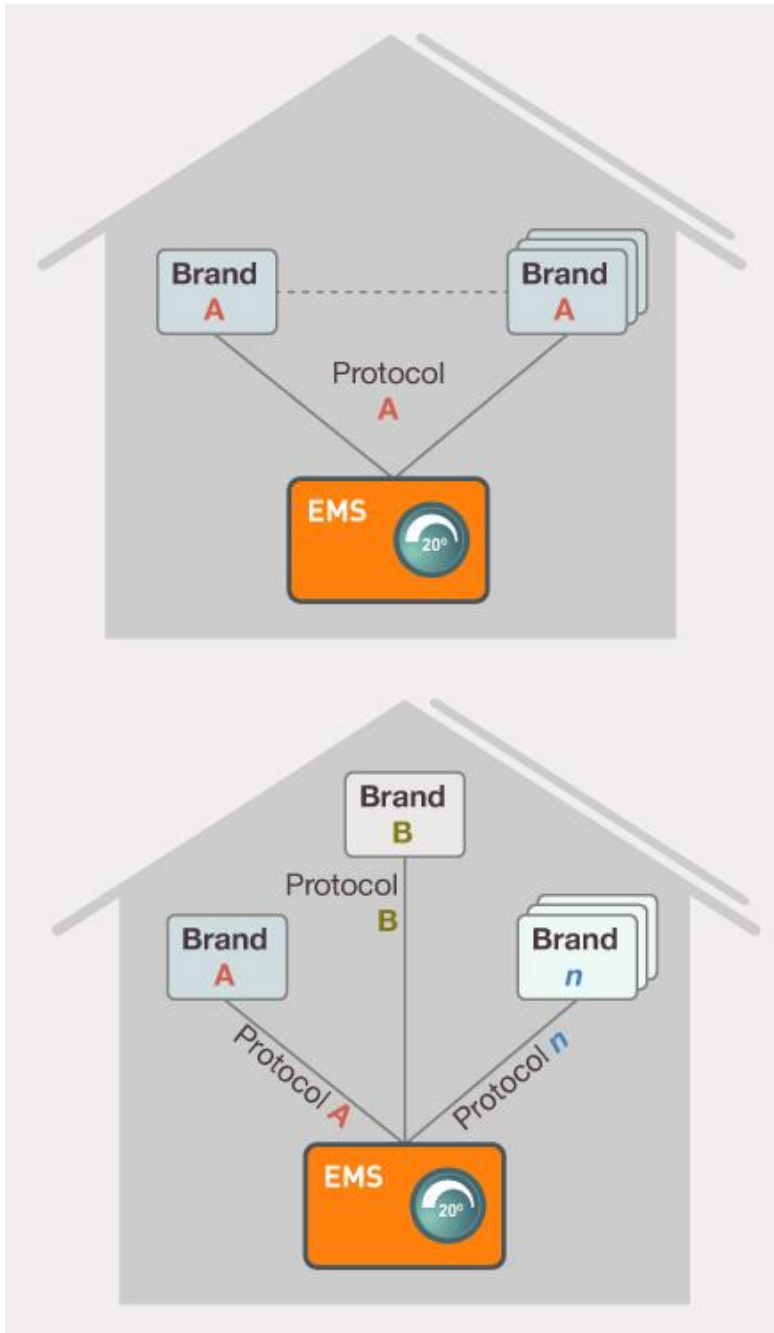

# Different approaches

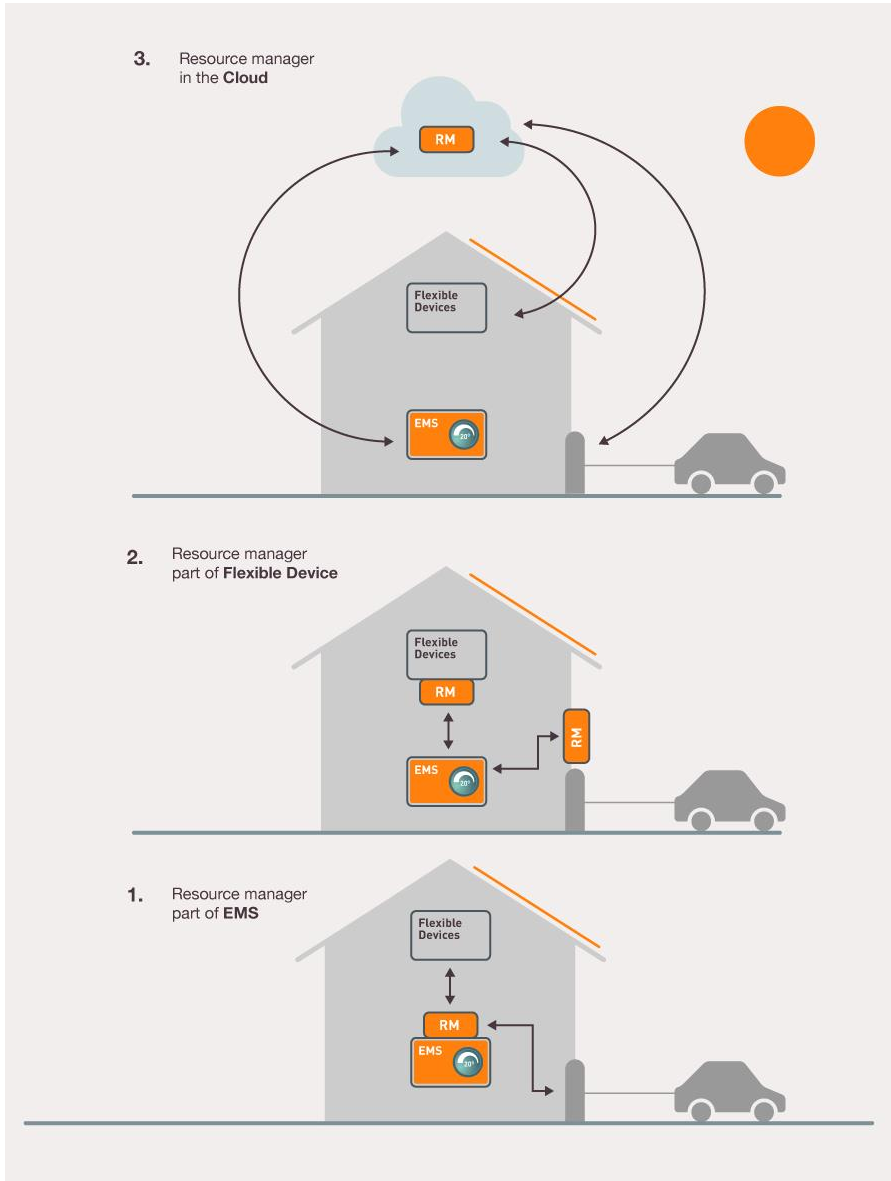



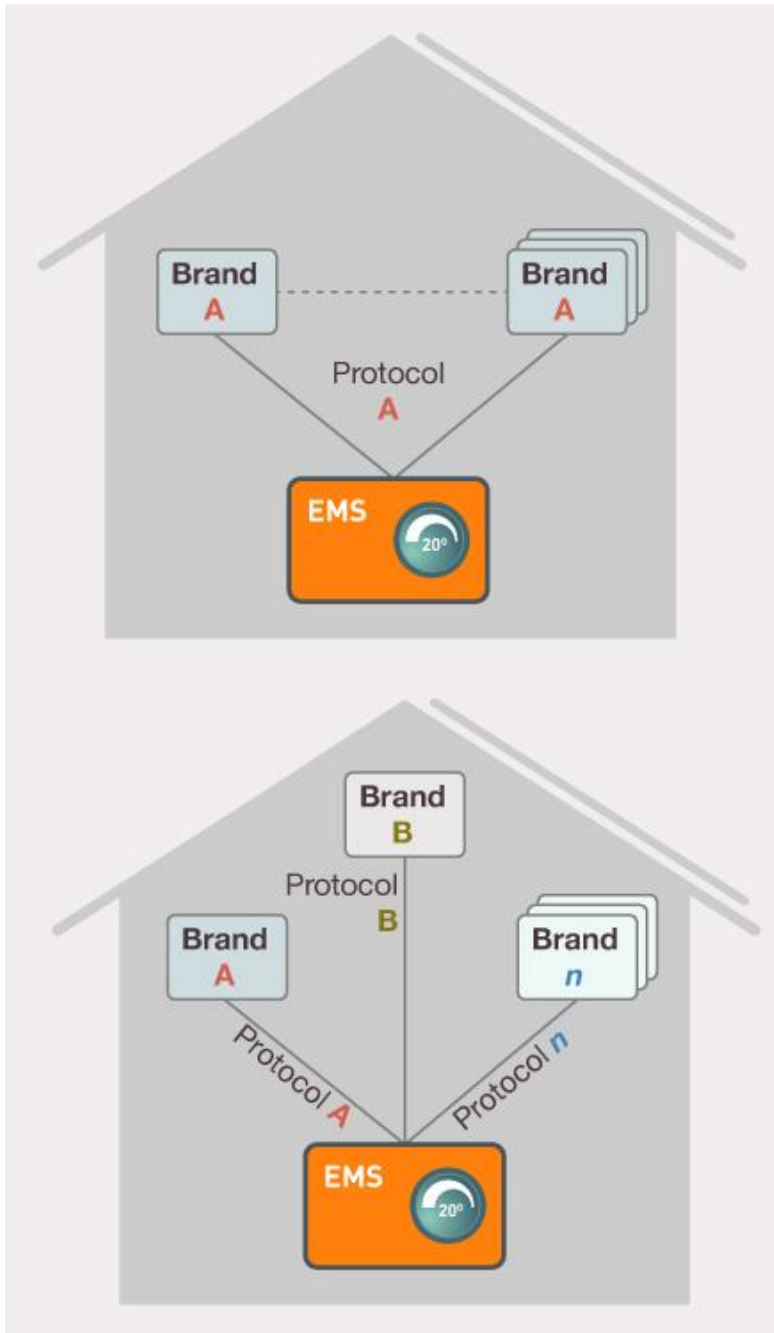

Different approaches

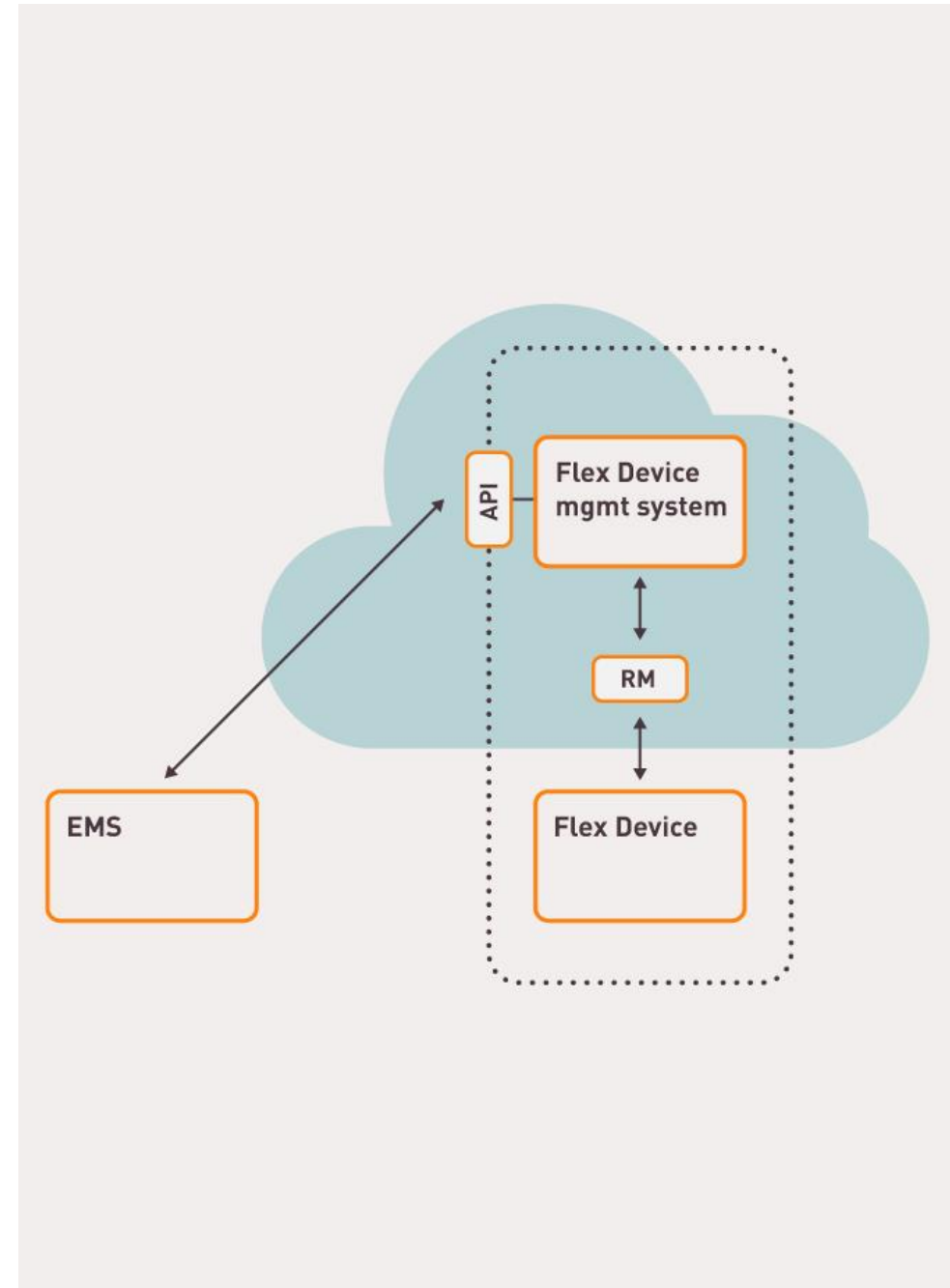



# SMART ENERGY COMMUNITY VOOR WONINGEN EN BEDRIJFSGEBOUWEN

## Poll 2

Welke benadering is volgens u het meest geschikt (om na te streven)?

1. Direct
2. Indirect



## Multiple suited protocols

	Version	Openness	Interoperability	Maturity	Registration	Energy flow reservation	Metering	Adjust capacity
ECHONET Lite	1.13	High	High	Medium/ High	●	○	○	○
EEBus SPINE	1.1.1	Medium/ High	High	Medium	●	●	●	●
EFI	2.0	Medium/ High	Medium/ High	Low	●	●	●	●
KNX	2.1	Medium	High*	High‡	●	○	●	○
OCF	2.1.0	Medium/ High	High*	Medium/ High	●	○	●	○
OCPP‡	2.0.1	Medium/ High	Medium*	Medium	●	○	●	○
SEP – IEEE 2030.5	2.0	High	Medium/ High	Medium/ High	●	●	●	●
OpenADR 2.0	1.1	High	Medium/ High*	High	●	○	●	●
Modbus ≡		High	Low	High	○	○	○	○



# Recommendations





# Highlighted recommendations

1 Coordination

2 Feasibility studies of indirect approach

3. Resource manager in the Cloud

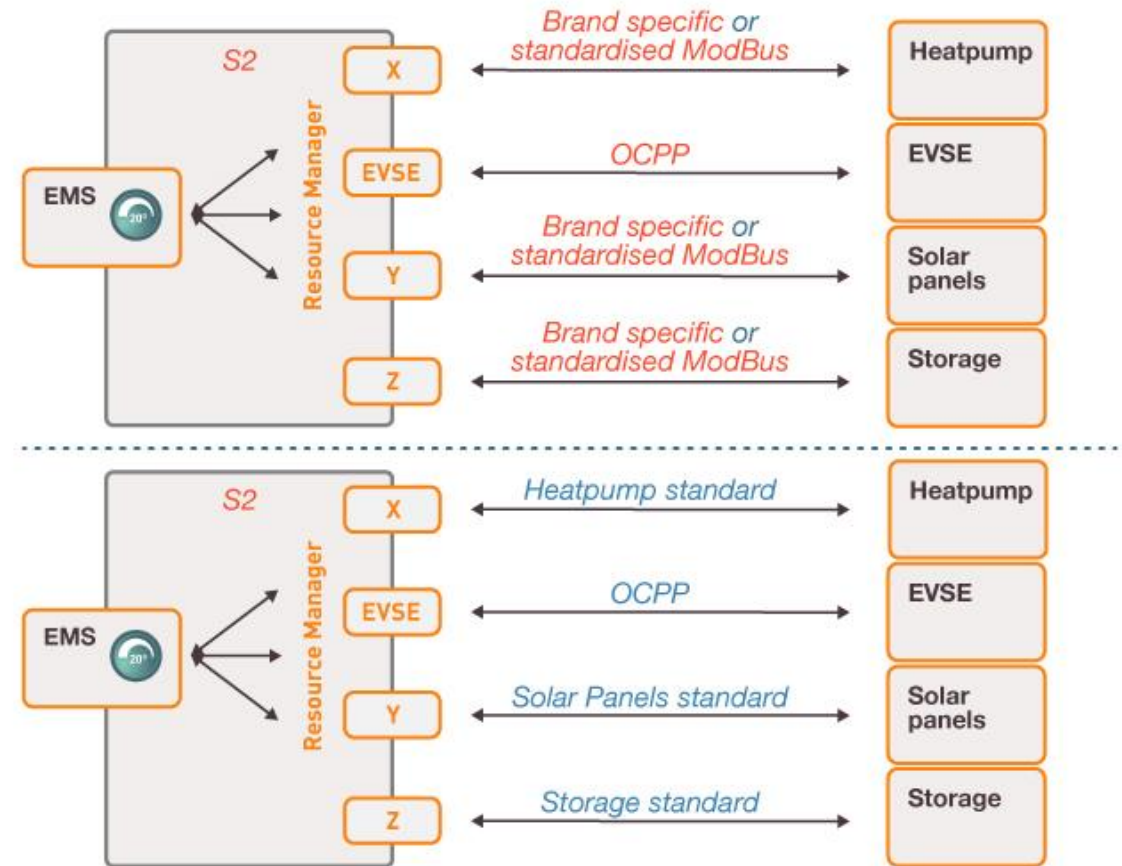
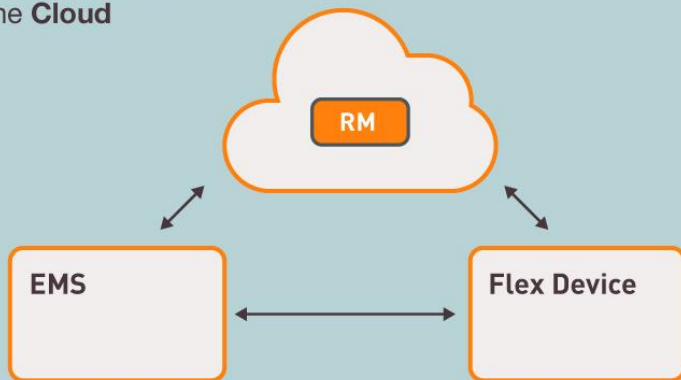



# In-home energy flexibility protocols



Arjan Wargers  
Manager Research & Innovation

[arjan.wargers@elaad.nl](mailto:arjan.wargers@elaad.nl)  
06-81641900